



MARANI HARD HOSE IRRIGATORS

Marani has one of the largest specific ranges of poly reel irrigators available in all markets worldwide ranging from a 40mm to a 160mm machine.

Marani assemble and offers to their customers the fourth generation turbine system, providing excellent results even at very low pressures: 2-3 bar when using the spray boom and 5-6 bar when using the rain gun.

The choke-flow turbine with built in bypass and flanged directly to a gearbox represents a significant advance in hose reel irrigators drive system and makes the system very reliable for a performance point of view.

The turbine is made with a special aluminium alloy and machined using

automatic machine tools. The current turbine-gearbox system has eliminated the transmission belt and the external bypasses.

The turbine is connected directly to the gearbox and the bypass is internal. This keeps the pressure absorption to a minimum, allowing the machine to run more smoothly.

Every machine is complete with its manuals and instruction stickers, spare parts lists and performance sheets to make the end user run the machine very easily by themselves.

WHY MARANI HARD HOSE IRRIGATORS?

FULLY GALVANIZED

- Corrosion resistance
- Extra durability

FOURTH GENERATION CHOKE FLOW

- Lower pressure loss over turbine
- More economical to run
- Gives a wider speed control range
- Direct coupled to gearbox

HDPE HOSE

- Manufactured to resist heavy drags
- Will work at high pressures

TACHOMETER

- Retraction speed can be instantly read out

DRUM SUPPORTS

- Drums are supported by large water proof bearings increasing drum life

HOSE GUIDE SYSTEM – SCROLL BAR

- Guarantees a perfect layering of the PE hose
- Reduces hose wear to a minimum



FAQS

BEING ITALIAN MADE, ARE THERE SPARE PARTS READILY AVAILABLE?

We already have a huge range of spare parts not only for Marani machines but for some other well known brands which are readily available in Brisbane.

WILL I GET BACK UP SUPPORT?

Yes. Rodney Industries and Vinidex are embarking on establishing a solid back up team to the industry with having 3 people dedicated to irrigator sales and support through RI and a team of sales people in every state to help with your enquiries. This adds up to approximately 20 people nationally for support.

WILL I SAVE MONEY COMPARED TO OTHER HARD HOSE GUN OPTIONS?

Yes. Due to the next generation turbine which is coupled to the gearbox and the HDPE pipe; it will work at a lower operating pressure to other machines on the market. This will mean that you can get lower energy bills, but also that you can get the higher flows required through smaller machines; saving on the capital outlay as well!

WHY IS IT THEY USE HDPE PIPE?

HDPE is stronger and has the ability to have a larger internal bore creating less friction loss whilst being able to take increase flows of water. Being a stronger PE, the likelihood of seeing damages to the pipe and gaining an extended life.

CAN I PUMP EFFLUENT?

Yes they can pump effluent; so long as it is fairly clean. They are pumping effluent in all parts of the world as many places around the globe only have effluent available to them for pumping in their agricultural markets.

I MAY WANT TO PUT A BOOM ATTACHMENT ON AT A LATER DATE; IS IT POSSIBLE?

This is as easy as unbolting the flange of the gun trolley and re-bolting the boom onto it. Of course you will have to adjust your pump to work within the pressures and flows of the booms specifications. We offer the Briggs range of folding booms which is universally recognized as the best booms in the industry.

Are they strong and durable machines?

Marani is recognized globally as having one of the strongest built machines. They have been building machines since 1970 and have stood the test of time. They have a very solid chassis and use the best technology available throughout the entire machine. Their gearbox is super tough whilst having a very user friendly gearbox and turbine structure.

ARE THEY STABLE WHEN OPERATING?

Yes. Marani have a very strong and over engineered leg design so that they get a correct rewinding. They go to such lengths in creating a machine that won't move that even their smallest machines have a full chassis to operate from.

WILL THEY MAINTAIN A CONSISTENT TRAVELLING SPEED?

Due to the full Marani range having a mechanical compensator which is adjustable, they maintain a very consistent travelling speed throughout the run. This can also be upgraded to a computer to have a more accurate timing of the run.



MARANI HARD HOSE IRRIGATORS

WHAT'S IN A TURBINE?

TURBINE SYSTEM FOR GT MODELS

Marani Fourth Generation Turbine and Gearbox used on GT Machines are proven for Low Pressure applications and the Gearbox has been used for Both Gun Trolley Boom Irrigators for over 10 years.

The Choked-Flow Turbine with built in bypass is flanged directly to the Gearbox. This also eliminates a Transmission belt and external by pass. This makes the system reliable from a performance point of view Turbine is made with special Aluminium and machined using CNC machining Centre.

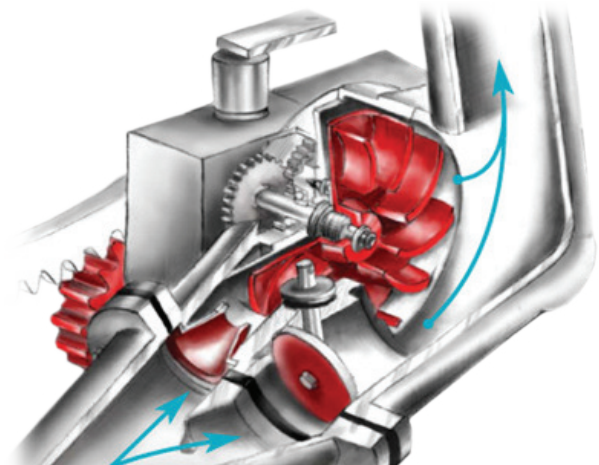

TURBINE SYSTEM FOR GTS AND ITS MODELS

The Marani GTS and ITS Models use the most efficient turbine on the market and when direct coupled with the new Gearbox they are proven to require less water and pressure, allowing more to flow through to your gun.

You can also easily see what speed you are in with the top gear change: 1-2-3-4.

- With the Lower gear change when in the Left position: hose is ready to pull-out & PTO wind-up.
- Centre position: drum lock down for transport
- Right position: working position

If a Foreign Object jams up the impeller just reverse the impeller by turning the outlet shaft next to turbine.

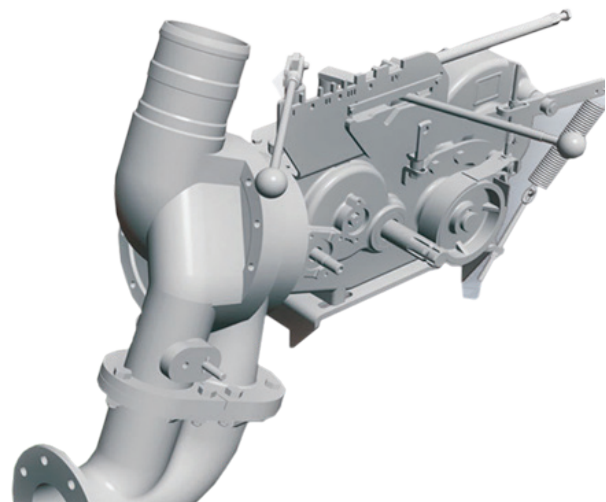

MA RAIN COMPUTERS



MA RAIN 26

The MA-Rain 26 computer features the following programmable functions:

- Working speed in m³/h or ft³/h.
- Delayed start (in minutes) before retraction starts.
- Delayed stop (in minutes) before opening or closing the discharge valve (optional) or the shut-off valve (optional).

The monitor then indicates:

- Remaining working time in hours and minutes.
- Working speed in m³/h or ft³/h.
- Meters/feet of unwound hose.



MA RAIN 56

The MA-Rain 56 computer features the following:

- Compact case.
- 4" high contrast, colour display.
- Optical encoder, for a fast selection of settings.
- 2 x 4 keys for navigation with back lighting.
- Additional keys for alarm setting.
- I/O control module.
- On/Off key.
- Commands and features have an intuitive graphical user interface, to avoid keys in the lingo.
- Detailed alarm chart, with explicit reference to the components.
- Fast and easy parameters'/datas' settings.
- Software's update with USB key.



CONSOLE RAIN COMPUTERS

Need to replace or upgrade your old MaterMacc Computer System?

CONSOLE RAIN 130



The Startec Console Rain 130 computer features the following:

- Allows the rewinding speed adjustment only by turning the knob on the desired speed.
- From 5 to 95 m/h (20-295 ft/h).
- It has to be connected to a roller speed sensor and to speed the adjustment motor.
- Power supplied by a 12 Volt battery.

The three leds indicate:

- The sensor functioning
- The adjustment motor functioning
- The battery charge

CONSOLE RAIN 260



Electronic control unit with back-lit LCD and 10 function-keys. It has to be linked to a system and to the speed adjustment motor and to an end-irrigation sensor. Power supplied with 12 Volt, by a battery.

Main Functions include:

- Measure of unwound hose
- Start irrigation/End irrigation
- Initial pause
- Rewinding at programmed speed, or programmed quantity (mm)•
- Final pause

Main Options include:

- GSM
- Flowmeter control of system



Making water work for you
www.dowdens.com.au

MACKAY (Head Office)
9-15 Industrial St, Mackay Qld 4740
Phone: 07 4969 4949
info@dowdens.com.au

ROCKHAMPTON
4/415 Yaamba Rd, Rockhampton Qld 4701
Phone: 07 4923 6969
info@dowdens.com.au

PROSERPINE
2 Mann St, Proserpine Qld 4800
Phone 07 4969 4940
info@dowdens.com.au

OPTIONS



DISCHARGE VALVE

Discharge membrane valve for automatic shut-off the engine pump (pump must have low pressure shut off).



SHUT OFF VALVE

This valve is operated by water piston or by an electric piston for water shut-off at machine inlet.

(Pump must have high pressure shut off).



BLOW-OUT COMPRESSOR

This enables you to empty the largest hose reels within 2-4 minute, thus making them easy to transport.



OFF-SET TROLLEY

5 Wheel off-set trolley. Ideal for avoiding hose damage to certain crops.



ENGINE DRIVE MACHINE

Optional hydraulic engine for winding in the hose on the drum and for driving all the hydraulics of the machine.



FULL HYDRAULICS

Operated by a spool valve using tractor hydraulics (or engine if engine drive) for rotating reel, adjusting tongue jack height and lowering/raising gun-cart and stabilizer legs. Ideal for positioning big machines under extreme working conditions.



MARANI HARD HOSE IRRIGATORS

MARANI ENQUIRY FORM

Farm Details

Dimensions: Area: Acres or Ha
 Run Length: Metres Run Widths: Metres
 Hydrant Spacings: Metres Slopes:
 Towing Lanes: Yes/No
 Water Supply Source: River / Dam / Bore / Well / Flooding / Channel / Other:
 Details of Water Quality:
 Flow Rate: GPH / LPH / LPM / M³H Supply Pressure: Bar/PSI
 Soil Type: Crops Grown:
 Required Watering Rate/s:
 Pump/engine protection system:

Drawing of Field Layout

Irrigator Details

Model: F010B GT015B GT020B GT022B GT030B GT030C GT040C GT050B GT060B GT070B
 GTS080B GTS080C GTS90C IT050B IT060B IT070B ITS080B ITS080C ITS090C IT100B
 Marani Boom: Yes/No
 Briggs Boom: Yes/No
 Hose Brand: Angus / Other Hose Size: mm x Metres
 Nozzle Brand: Nelson R3000 / Senninger XiWob
 Gun Brand: Nelson / SIME / Komet
 Other: Computer / Purge / High or Low Pressure Shut Down / Hydraulic Options

Notes

.....

MARANI HARD HOSE IRRIGATORS

FIELD LAYOUT

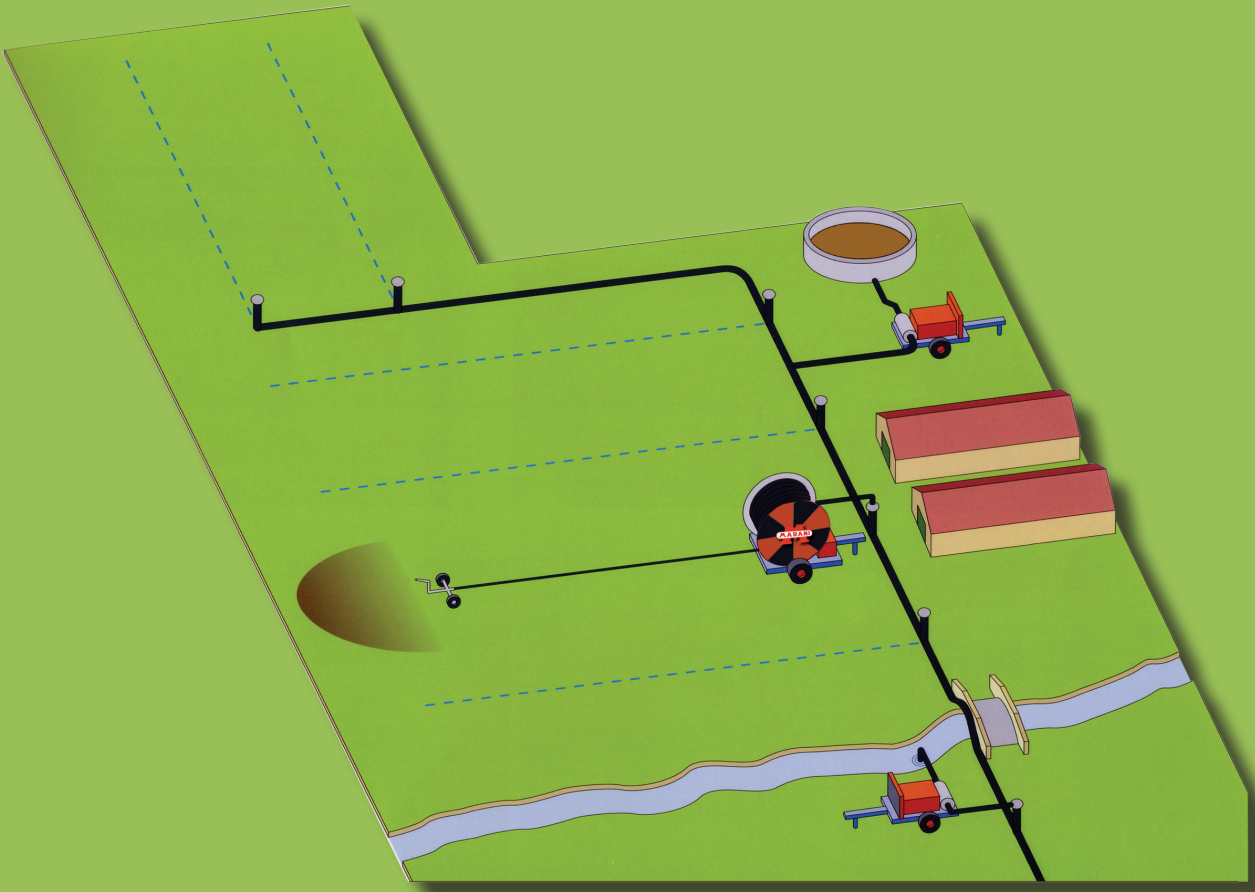

Making water work for you
www.dowdens.com.au

MACKAY (Head Office)
9-15 Industrial St, Mackay Qld 4740
Phone: 07 4969 4949
info@dowdens.com.au

ROCKHAMPTON
4/415 Yaamba Rd, Rockhampton Qld 4701
Phone: 07 4923 6969
info@dowdens.com.au

PROSERPINE
2 Mann St, Proserpine Qld 4800
Phone 07 4969 4940
info@dowdens.com.au

THE RANGE



F010B



GT015B



GT020B



GT022B



GT026B



GT030B/C



GT040C



GT050B



GT060B



GT070B

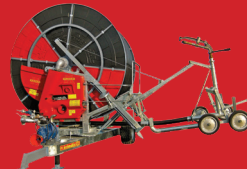

GTS080B/C



GTS090B



IT050B



IT060B



IT070B



ITS080B/C



ITS090C



IT100B

F010B



TECHNICAL DATA

Model	Pressure at Inlet (BAR)	Flow Rate (L/M)	Wetted Width at 80% (Mtr)
40/130	3.6 – 7.7	71-155	28-34
50/170	3.1 – 8.8	88-277	29-46

Description	Code
F010B 40mm x 130m	A F010B40130
SIME K1 24° Part Circle Gun	(gun included)
F010B 50mm x 170m	J F010B50170
SIME Hidra Part Circle	(gun included)

Option	Code
Computer Ma-Rain 26 kit c/w solar panel and pressure switch	35462701KIT

SIZES AVAILABLE

- 40mm x 130m
- 50mm x 170m

STANDARD EQUIPMENT

- Pressure gauge (glycerine bath)
- Mechanical feet
- Hot galvanized chassis and reel
- Single Gear Multi Speed gearbox
- Winding handle
- Water Inlet Shut-Off Valve
- Safety guards
- Flexible connection pipe 2" x 6m
- Galvanized raingun trolley
- Turbine flanged on the gearbox with external bypass

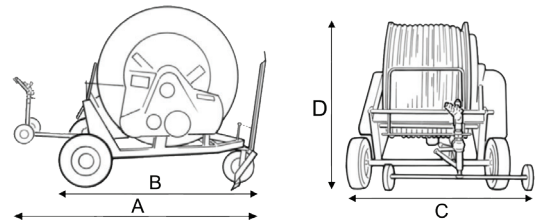

SIZE (cm)			
A	B	C	D
279	190	130	162

Dry Weight 398 kg

* Please note dimensions and weights are to be used as a guide only.

MARANI HARD HOSE IRRIGATORS



GT015B



TECHNICAL DATA

Model	Pressure at Inlet (BAR)	Flow Rate (L/M)	Wetted Width at 80% (Mtr)
58/200	3.3 – 8.0	152 - 351	32 - 48
63/150	3.0 – 9.7	174-560	41-70

Description		Code
GT015B 58mm x 200m	C	GT015B58200
GT015B 63mm x 150m	I	GT015B63150
SIME Hidra Part Circle		140020
Nelson P85 Gun		18783K

Options	Code
Computer Ma-Rain 26 kit c/w solar panel and pressure switch	35462701KIT

SIZES AVAILABLE

- 58mm x 200m
- 63mm x 150m

STANDARD EQUIPMENT

- Automatic lifting device of trolley
- P.T.O.
- Turbine flanged on the gearbox with external bypass
- Single gear multi speed gearbox
- Hose guide system
- Flexible connection pipe 2" x 6m
- Automatic lifting device of trolley
- Safety guards
- Pressure gauge (glycerine bath)
- Galvanized raingun trolley mounted on variable track wheels
- Hot Galvanized chassis, turret and reel
- Winding handle
- Water Inlet Shut-Off Valve



! NOTE !

- Specify gun when ordering
- Computer needed for high water application rates.

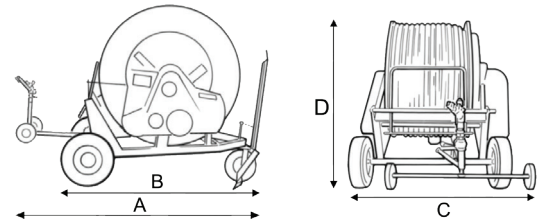

SIZE (cm)			
A	B	C	D
330	250	130	192

Dry Weight 980 kg

* Please note dimensions and weights are to be used as a guide only.

GT020B



TECHNICAL DATA

Model	Pressure at Inlet (BAR)	Flow Rate (L/M)	Wetted Width at 80% (Mtr)
63/200	3.6 – 11.1	230 – 606	40 - 61

Description	Code
GT020B 63mm x 200m	J GT020B63200
SIME Hidra Part Circle	140020
Nelson P85 Gun	18783K

SIZES AVAILABLE

- 63mm x 200m

STANDARD EQUIPMENT

- Mechanical lifting device trolley
- Hot galvanized chassis and reel
- Telescopic mechanical feet
- Winding handle
- Single speed gearbox
- Safety guards
- Galvanized raingun trolley mounted on variable track wheels
- P.T.O.
- Mechanical lifting device trolley
- Flexible connection pipe 2" x 6m
- Pressure gauge (glycerine bath)
- Turbine flanged on the gearbox with external by-pass
- Water inlet shut off
- Computer Ma Rain 26
- Pressure switch
- Solar Panel



! NOTE !

- Specify gun when ordering
- Computer needed for high water application rates.

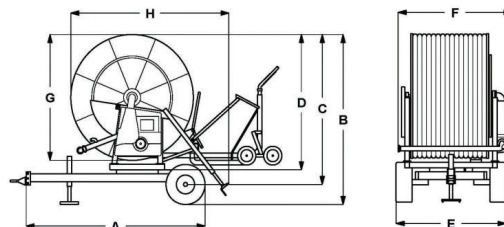

SIZE (cm)							
A	B	C	D	E	F	G	H
240	218	192	200	166	135	158	175

Dry Weight 800 kg

* Please note dimensions and weights are to be used as a guide only.

MARANI HARD HOSE IRRIGATORS



GT022B



TECHNICAL DATA

Model	Pressure at Inlet (BAR)	Flow Rate (L/M)	Wetted Width at 80% (Mtr)
63/250	4 – 10.1	230 – 520	40 – 54
75/250	4.4 – 10.8	276 – 708	51 - 75

Description		Code
GT022B 63mm x 250m	G	GT022B63250
SIME Hydra Part Circle		140020
Nelson P85 Gun		18783K
GT022B 75mm x 250m	I	GT022B75250
SIME Royal		140036KIT
Nelson SR100 Gun		SR100K
Komet 101 Ultra Kit		5010253KIT

Option	Code
MA-RAIN 26 Kit c/w solar panel and pressure switch	35462703KIT
Ma-Rain 56 Kit	35510120SKIT

SIZES AVAILABLE

- 63mm x 250m
- 75mm x 250m

STANDARD EQUIPMENT

- Mechanical lifting device of trolley
- Flexible connection pipe with storage reel
- Telescopic mechanical feet
- Pressure gauge (glycerine bath)
- 3 Speed gearbox
- Speed equalizer
- PTO
- Hot galvanized chassis and reel
- Mechanical lifting device of trolley
- Winding handle
- Water Inlet Shut-Off Valve
- Safety guards
- Turbine mounted on the gearbox with built-in bypass
- Galvanized raingun trolley mounted on variable track hard rubber wheels



! NOTE !

- Specify gun when ordering
- Computer needed for high water application rates.

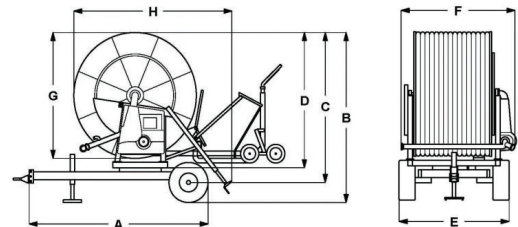

SIZE (cm)							
A	B	C	D	E	F	G	H
290	230	200	180	175	170	169	225

Dry Weight 1047 kg

* Please note dimensions and weights are to be used as a guide only.

GT026B

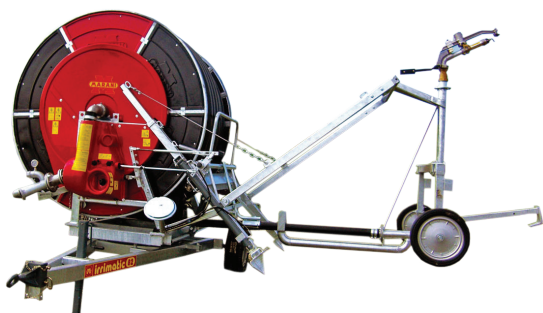

TECHNICAL DATA

Model	Pressure at Inlet (BAR)	Flow Rate (L/M)	Wetted Width at 80% (Mtr)
75/300	3 – 10.4	174 - 586	40 - 72
90/250	4.6 – 10.9	522 – 1149	59 - 86

Description		Code
GT026B 75mm x 300m	H	GT026B75300
SIME Royal		140036KIT
Nelson SR100 Gun		SR100K
Komet 101 Ultra Kit		5010253KIT
GT026B 90mm x 250m	G	GT026B90250
SIME Reflex		140052KIT
Nelson SR100 Gun		SR100K
Komet 101 Ultra Kit		5010253KIT

Option	Code
Ma-Rain 26 Kit c/w solar panel and pressure switch	35462703KIT
Ma-Rain 56 Kit	35510120SKIT
Tachometer	35462711
Hydraulic Rotation with Hydraulic Lift of Trolley and Hydraulic Lift of Drawbar with Tractor Jacks	80420300

SIZES AVAILABLE

- 75mm x 300m
- 90mm x 250m

STANDARD EQUIPMENT

- Mechanical lifting device of trolley
- Pressure gauge (glycerine bath)
- Telescopic mechanical feet
- Speed equalizer
- 3 Speed gearbox
- Hot galvanized chassis and reel
- PTO
- Water Inlet Shut-Off Valve
- Galvanized raingun trolley mounted on variable track hard rubber wheels
- Turbine mounted on the gearbox with built-in bypass
- Winding handle
- Safety guards
- Flexible connection pipe with storage reel



! NOTE !

- Specify gun when ordering
- Computer needed for high water application rates.

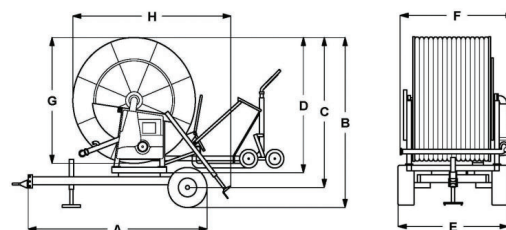

SIZE (cm)							
A	B	C	D	E	F	G	H
325	265	235	225	195	193	199	255

Dry Weight 1300 kg

* Please note dimensions and weights are to be used as a guide only.

MARANI HARD HOSE IRRIGATORS



GT030B



TECHNICAL DATA

Model	Pressure at Inlet (BAR)	Flow Rate (L/M)	Wetted Width at 80% (Mtr)
75/350	3 – 10.8	174 – 586	40 – 72
90/300	4.8 – 10.8	522 – 1096	59 – 83
90/350	5.1 – 10.8	522 – 1040	59 - 80

Description		Code
GT030B 75mm x 350m	D	GT030B75350
SIME Royal		140036KIT
Nelson SR100 Gun		SR100K
Komet 101 Ultra Kit		5010253KIT
GT030B 90mm x 300m	I	GT030B90300
GT030B 90mm x 350m	B	GT030B90350
SIME Reflex		140052KIT
Nelson SR150 Gun		SR150K
Komet 101 Ultra Kit		5010253KIT

Option	Code
Ma-Rain 26 Kit c/w solar panel and pressure switch	35462700KIT
Ma-Rain 56 Kit	35510120SKIT
Hydraulic Rotation with Hydraulic Lift of Trolley and Hydraulic Lift of Drawbar with Tractor Jacks	80430300
Emptying compressor mounted on special drawbar	80590000SKIT

SIZES AVAILABLE

- 75mm x 350m
- 90mm x 300m
- 90mm x 350m

STANDARD EQUIPMENT

- Mechanical lifting device of trolley
- Hot galvanized chassis and reel
- Telescopic mechanical feet
- Pressure gauge (glycerine bath)
- 6 Speed gearbox
- Tachometer
- PTO
- Flexible connection pipe with storage reel
- Turbine mounted on the gearbox with built-in bypass
- Galvanized raingun trolley mounted on variable track hard rubber wheels
- Speed equalizer
- Safety guards
- Water Inlet Shut-Off Valve
- Winding handle



! NOTE !

- Specify gun when ordering

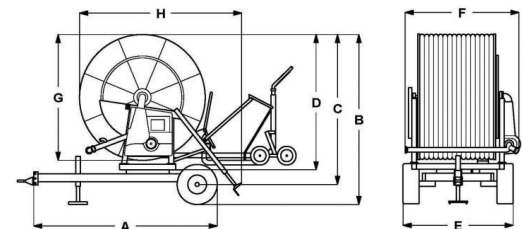

SIZE (cm)							
A	B	C	D	E	F	G	H
330	296	265	245	205	225	224	280

Dry Weight 1907 kg

* Please note dimensions and weights are to be used as a guide only.

GT030C

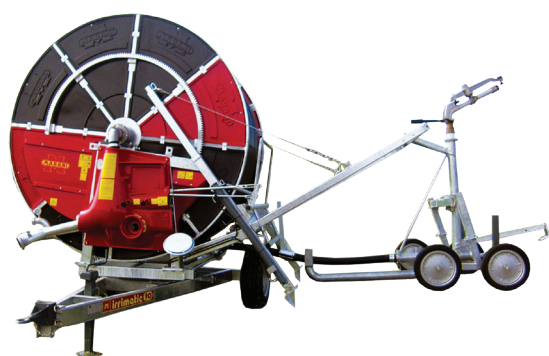

TECHNICAL DATA

Model	Pressure at Inlet (BAR)	Flow Rate (L/M)	Wetted Width at 80% (Mtr)
110/250	3.7 – 9.9	522 – 1570	59 - 94

Description	Code
GT030C 110mm x 250m	GT030C110250
SIME Reflex	140052KIT
Nelson SR150 Gun	SR150K
Komet 140 Ultra Kit	5010254KIT

Option	Code
Ma-Rain 26 Kit c/w solar panel and pressure switch	35462700KIT
Ma-Rain 56 Kit	35510120SKIT
Hydraulic Rotation with Hydraulic Lift of Trolley and Hydraulic Lift of Drawbar with Tractor Jacks	80430300
Emptying compressor mounted on special drawbar	80590000SKIT

SIZES AVAILABLE

- 110mm x 250m

STANDARD EQUIPMENT

- Mechanical lifting device of trolley
- Hot galvanized chassis and reel
- Speed equalizer
- Telescopic mechanical feet
- Pressure gauge (glycerine bath)
- Safety guards
- 6 Speed gearbox
- Tachometer
- Water Inlet Shut-Off Valve
- PTO
- Flexible connection pipe with storage reel
- Winding handle
- Turbine mounted on the gearbox with built-in bypass
- Galvanized raingun trolley mounted on variable track hard rubber wheels



! NOTE !

- Specify gun when ordering

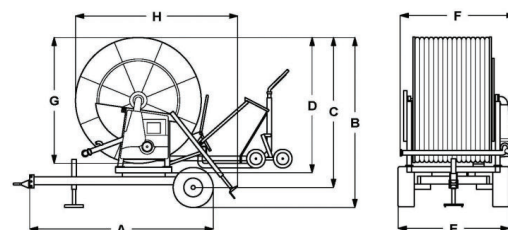

SIZE (cm)							
A	B	C	D	E	F	G	H
330	296	265	245	205	225	224	280

Dry Weight 1907 kg

* Please note dimensions and weights are to be used as a guide only.

MARANI HARD HOSE IRRIGATORS



GTO40C

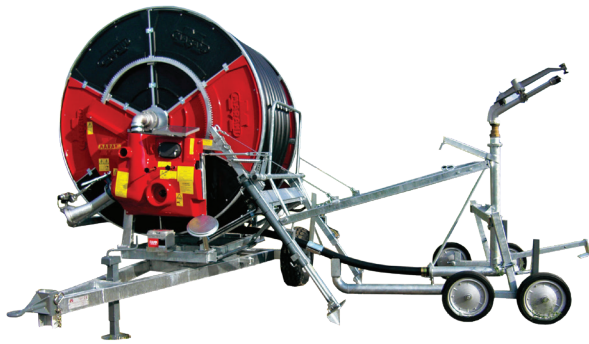

TECHNICAL DATA

Model	Pressure at Inlet (BAR)	Flow Rate (L/M)	Wetted Width at 80% (Mtr)
110/300	4.4 – 10.5	732 – 1570	66 - 94

Description	Code
GT040C 110mm x 300m	H
SIME Reflex	140052KIT
SIME Mariner Big Gun	140075KIT
Nelson SR150 Gun	SR150K
Komet 160 Ultra Kit	5010255KIT

Option	Code
Ma-Rain 26 Kit c/w solar panel and pressure switch	35462700KIT
Ma-Rain 56 Kit	35510120SKIT
Hydraulic Rotation with Hydraulic Lift of Trolley and Hydraulic Lift of Drawbar with Tractor Jacks	80440300
Emptying Compressor	75430550

SIZES AVAILABLE

- 110mm x 300m

STANDARD EQUIPMENT

- Telescopic hydraulic feet
- Pressure gauge (glycerine bath)
- Speed equalizer
- 6 Speed gearbox
- Tachometer
- Winding handle
- Hot galvanized chassis and reel
- Safety guards
- Water Inlet Shut-Off Valve
- PTO
- Flexible connection pipe with storage reel
- Turbine mounted on the gearbox with built-in bypass
- Hydraulic lifting device of trolley by hand pump
- Galvanized raingun trolley mounted on variable track hard rubber wheels
- 5 wheel trolley



! NOTE !

- Specify gun when ordering

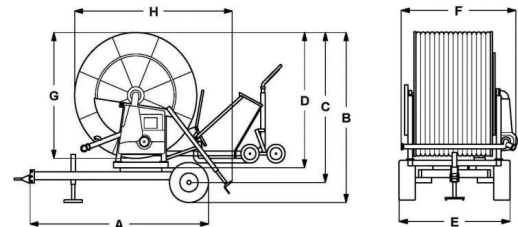

SIZE (cm)							
A	B	C	D	E	F	G	H
340	324	296	270	210	225	246	295

Dry Weight 2470 kg

* Please note dimensions and weights are to be used as a guide only.

GT050B



TECHNICAL DATA

Model	Pressure at Inlet (BAR)	Flow Rate (L/M)	Wetted Width at 80% (Mtr)
110/350	4.3 – 11.2	623 – 1570	62 - 94

Description	Code
GT050B 110mm x 350m	GT050B110350
SIME Reflex	140052KIT
SIME Mariner Big Gun	140075KIT
Nelson SR150 Gun	SR150K
Komet 160 Ultra Kit	5010255KIT

Option	Code
Ma-Rain 26 Kit c/w solar panel and pressure switch	35462700KIT
Ma-Rain 56 Kit	35510120SKIT
Hydraulic Rotation with Hydraulic Lift of Trolley and Hydraulic Lift of Drawbar with Tractor Jacks	80460300S
Emptying Compressor	75430550

SIZES AVAILABLE

- 110mm x 350m

STANDARD EQUIPMENT

- Telescopic hydraulic feet
- Pressure gauge (glycerine bath)
- Speed equalizer
- 4 Speed gearbox
- Tachometer
- Winding handle
- Hot galvanized chassis and reel
- Safety guards
- Water Inlet Shut-Off Valve
- PTO
- Flexible connection pipe with storage reel
- Mechanical lift of drawbar
- Hydraulic lifting device of trolley by hand pump
- Galvanized raingun trolley mounted on variable track hard rubber wheels
- Turbine mounted on the gearbox with built-in bypass
- 5 wheel trolley



! NOTE !

- Specify gun when ordering

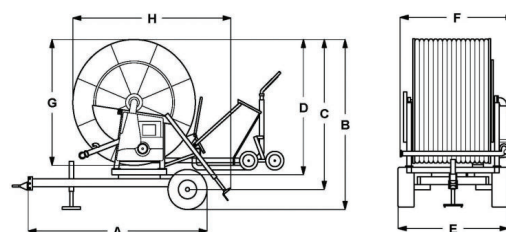

SIZE (cm)							
A	B	C	D	E	F	G	H
420	353	318	286	228	240	268	350

Dry Weight 2795 kg

* Please note dimensions and weights are to be used as a guide only.

MARANI HARD HOSE IRRIGATORS



GT060B



TECHNICAL DATA

Model	Pressure at Inlet (BAR)	Flow Rate (L/M)	Wetted Width at 80% (Mtr)
110/400	4.5 – 11.3	623 – 1501	62 – 92
110/420	4.6 - 10.6	623 – 1320	62 - 90
110/450	4.4 – 11.9	522 – 1501	59 – 91
125/350	4.3 – 11.2	848 - 1913	70 - 109

Description	Code
GT060B 110mm x 400m	G GT060B110400
GT060B 110mm x 420m	H GT060B110420
GT060B 110mm x 450m	J GT060B110450
GT060B 125mm x 350m	H GT060B125350
SIME Reflex	140052KIT
SIME Mariner Big Gun	140075KIT
Nelson SR150 Gun	SR150K
Komet 160 Ultra Kit	5010255KIT

Option	Code
Ma-Rain 26 Kit c/w solar panel and pressure switch	35462700KIT
Ma-Rain 56 Kit	35510120SKIT
Hydraulic Rotation with Hydraulic Lift of Trolley and Hydraulic Lift of Drawbar with Tractor Jacks	80460300S
Emptying Compressor	75430550

SIZES AVAILABLE

- 110mm x 400m
- 110mm x 420m
- 110mm x 450m
- 125mm x 350m

STANDARD EQUIPMENT

- Telescopic hydraulic feet
- Pressure gauge (glycerine bath)
- Speed equalizer
- 4 Speed gearbox
- Tachometer
- Winding handle
- Hot galvanized chassis and reel
- Safety guards
- Water Inlet Shut-Off Valve
- PTO
- Flexible connection pipe with storage reel
- Mechanical lift of drawbar
- Hydraulic lifting device of trolley by hand pump
- Galvanized raingun trolley mounted on variable track hard rubber wheels
- Turbine mounted on the gearbox with built-in bypass
- 5 wheel trolley



! NOTE !

- Specify gun when ordering

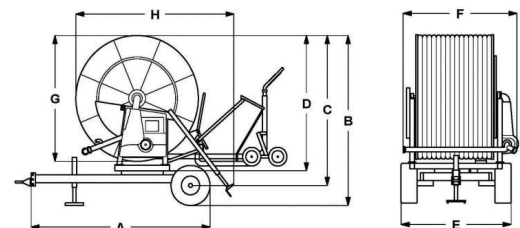

SIZE (cm)							
A	B	C	D	E	F	G	H
375	360	320	303	240	233	280	335

Dry Weight 3699 kg

* Please note dimensions and weights are to be used as a guide only.



MARANI HARD HOSE IRRIGATORS

GT070B



TECHNICAL DATA

Model	Pressure at Inlet (BAR)	Flow Rate (L/M)	Wetted Width at 80% (Mtr)
110/500	4.5 – 11.5	522 - 1202	59 - 88
125/400	4.4 – 10.9	848 – 1988	70 - 106

Description		Code
GT070B 110mm x 500m	D	GT070B110500
GT070B 125mm x 400m	H	GT070B125400
SIME Explorer Big Gun 25°		140055KIT
Nelson SR200 Gun		SR200K
Komet 160 Ultra Kit		5010255KIT

Option	Code
Ma-Rain 26 Kit c/w solar panel and pressure switch	35462700KIT
Ma-Rain 56 Kit	35510120SKIT
Hydraulic Rotation with Hydraulic Lift of Trolley and Hydraulic Lift of Drawbar with Tractor Jacks	80460300S
Emptying Compressor	75430550

SIZES AVAILABLE

- 110mm x 500m
- 125mm x 400m

STANDARD EQUIPMENT

- Telescopic hydraulic feet
- Pressure gauge (glycerine bath)
- Speed equalizer
- 4 Speed gearbox
- Tachometer
- Winding handle
- Hot galvanized chassis and reel
- Safety guards
- Water Inlet Shut-Off Valve
- PTO
- Flexible connection pipe with storage reel
- Mechanical lift of drawbar
- Hydraulic lifting device of trolley by hand pump
- Galvanized raingun trolley mounted on variable track hard rubber wheels
- Turbine mounted on the gearbox with built-in bypass
- 2 Large flotation wheels
- 5 Wheel trolley



! NOTE !

- Specify gun when ordering

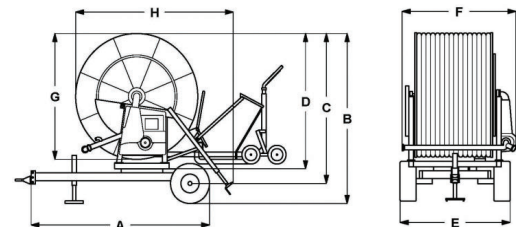

SIZE (cm)							
A	B	C	D	E	F	G	H
375	385	345	325	243	235	309	360

Dry Weight 3650 kg

* Please note dimensions and weights are to be used as a guide only.

MARANI HARD HOSE IRRIGATORS



GTS080B

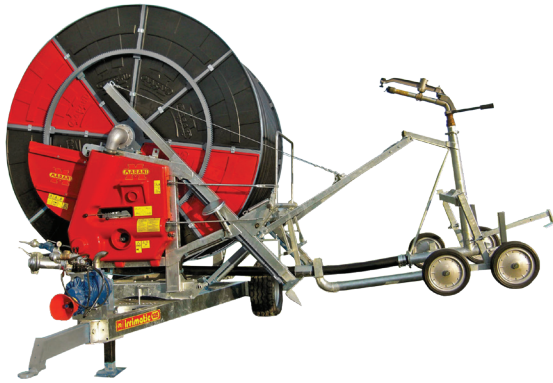

TECHNICAL DATA

Model	Pressure at Inlet (BAR)	Flow Rate (L/M)	Wetted Width at 80% (Mtr)
125/450	4.6 – 11.0	848 – 1901	70 – 102
125/500	4.7 – 11.4	848 – 1774	70 – 102
140/380	4.1 – 11.2	974 – 2648	77 - 117

Description	Code
GTS080B 125mm x 450m	D GTS080B125450
GTS080B 125mm x 500m	B GTS080B125500
GTS080B 140mm x 380m	J GTS080B140380
SIME Explorer Big Gun 25°	140055KIT
SIME Gemini 25° 2 Speed	140085KIT
Nelson SR200 Gun	SR200K
Komet 202 Ultra Kit	5010256KIT

Option	Code
Ma-Rain 26 Kit c/w solar panel and pressure switch	35462700KIT
Ma-Rain 56 Kit	35510120SKIT
All Hydraulic	80485400
Emptying Compressor	75430550

SIZES AVAILABLE

- 125mm x 450m
- 125mm x 500m
- 140mm x 380m

STANDARD EQUIPMENT

- Telescopic hydraulic feet
- Pressure gauge (glycerine bath)
- Speed equalizer
- Stabilizers on drawbar
- Tachometer
- Winding handle
- Hot galvanized chassis and reel
- Safety guards
- Water Inlet Shut-Off Valve
- PTO
- Flexible connection pipe with storage reel
- Mechanical lift of drawbar
- Hydraulic lifting device of trolley by hand pump
- Galvanized raingun trolley mounted on variable track hard rubber wheels
- Turbine mounted on the gearbox with built-in bypass
- 4 Speed gearbox with synchronised speeds
- 4 Wheel chassis
- 5 Wheel trolley



! NOTE !

- Specify gun when ordering

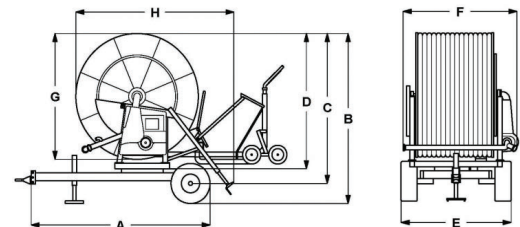

SIZE (cm)							
A	B	C	D	E	F	G	H
364	400	358	340	235	243	309	350

Dry Weight 4775 kg

GTS080C

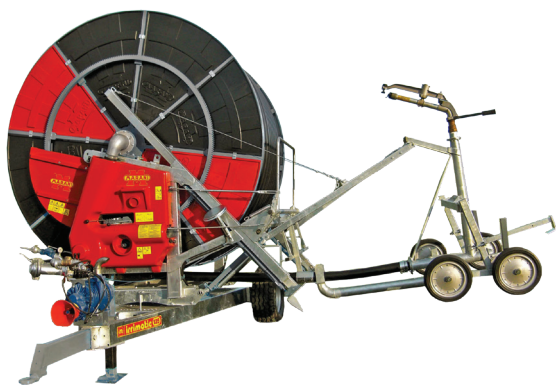

TECHNICAL DATA

Model	Pressure at Inlet (BAR)	Flow Rate (L/M)	Wetted Width at 80% (Mtr)
140/400	4.2 - 12.0	974 - 2648	77 - 117
140/450	4.3 - 10.9	974 - 2455	77 - 110

Description	Code
GTS080C 140mm x 400m	A GTS080C140400
GTS080C 140mm x 450m	A GTS080C140450
SIME Explorer Big Gun 25°	140055KIT
SIME Gemini 25° 2 Speed	140085KIT
Nelson SR200 Gun	SR200K
Komet 202 Ultra Kit	5010256KIT

Option	Code
Ma-Rain 26 Kit c/w solar panel and pressure switch	35462700KIT
Ma-Rain 56 Kit	35510120SKIT
All Hydraulic	80485400
Emptying Compressor	75430550

SIZES AVAILABLE

- 140mm x 400m
- 140mm x 450m

STANDARD EQUIPMENT

- Telescopic hydraulic feet
- Pressure gauge (glycerine bath)
- Speed equalizer
- Stabilizers on drawbar
- Tachometer
- Winding handle
- Hot galvanized chassis and reel
- Safety guards
- Water Inlet Shut-Off Valve
- PTO
- Flexible connection pipe with storage reel
- Mechanical lift of drawbar
- Hydraulic lifting device of trolley by hand pump
- Galvanized raingun trolley mounted on variable track hard rubber wheels
- Turbine mounted on the gearbox with built-in bypass
- 4 Speed gearbox with synchronised speeds
- 4 Wheel chassis
- 5 Wheel trolley



! NOTE !

- Specify gun when ordering

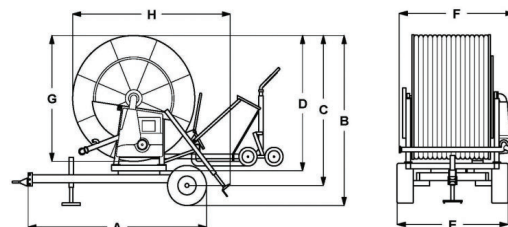

SIZE (cm)							
A	B	C	D	E	F	G	H
364	400	358	340	235	243	309	350

Dry Weight 4775 kg

* Please note dimensions and weights are to be used as a guide only.

MARANI HARD HOSE IRRIGATORS



GTS090C



TECHNICAL DATA

Model	Pressure at Inlet (BAR)	Flow Rate (L/M)	Wetted Width at 80% (Mtr)
140/500	4.4 – 11.5	974 - 2455	77 - 110

Description		Code
GTS090C 140mm x 500m	B	GTS090C140500
SIME Explorer Big Gun 25°		140055KIT
SIME Gemini 25° 2 Speed		140085KIT
Nelson SR200 Gun		SR200K
Komet 202 Ultra Kit		5010256KIT

SIZES AVAILABLE

- 140mm x 500m

STANDARD EQUIPMENT

- 4 wheel chassis
- Flexible connection pipe
- Computer Ma-Rain 56
- Hydraulic lifting device of trolley
- PTO
- Hose retraction by double chain
- Hydraulic rotation of turntable
- Water Inlet Shut-Off valve
- Hot galvanized chassis and reel
- Hydraulic system by rapid couplings to tractor with storage reel
- 5 Wheel trolley with variable track hard rubber wheels
- Turbine mounted on the gearbox with built-in bypass
- Telescopic hydraulic feet
- Pressure gauge (glycerine bath)
- Winding handle
- Hydraulic lifting of drawbar
- Safety guards made of steel swaged galvanised and painted
- 4 Speed gearbox with synchronised speeds
- Electric shut off valve
- Pressure Switch
- Emptying Compressor

▼ Trolley position - end of run

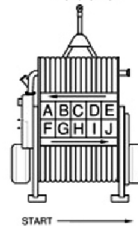

! NOTE !

- Specify gun when ordering

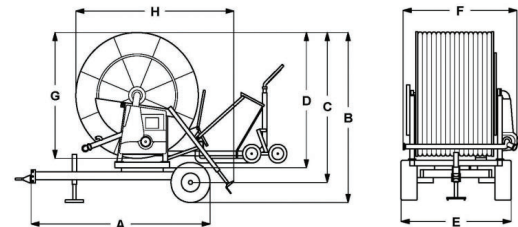

SIZE (cm)							
A	B	C	D	E	F	G	H
440	451	416	376	255	243	334	440

Dry Weight 6179 kg

* Please note dimensions and weights are to be used as a guide only.

IT050B



TECHNICAL DATA

Model	Pressure at Inlet (BAR)	Flow Rate (L/M)	Wetted Width at 80% (Mtr)
110/300	4.4 – 10.5	732 – 1570	66 – 94
110/350	4.3 – 11.2	623 – 1570	62 - 94

Description		Code
IT050B 110mm x 300m	F	IT050B110300
IT050B 110mm x 350m	I	IT050B110350
SIME Reflex		140052KIT
SIME Mariner 25° 2 Speed		140080KIT
Nelson SR150 Gun		SR150K
Komet 160 Ultra Kit		5010255KIT

Option	Code
Ma-Rain 26 Kit c/w solar panel and pressure switch	35462700KIT
Ma-Rain 56 Kit	35510120SKIT
Emptying Compressor	75430550

SIZES AVAILABLE

- 110mm x 300m
- 110mm x 350m

STANDARD EQUIPMENT

- Hydraulic lifting device of trolley
- 4 Speed gearbox
- Water Inlet Shut-Off Valve
- Hydraulic rotation of turntable
- PTO
- Pressure gauge (glycerine bath)
- Hydraulic feet
- Flexible connection pipe with storage reel
- Tachometer
- Hydraulic lift of drawbar
- Hot galvanized chassis and reel
- Speed equalizer
- Winding handle
- Safety guards
- Turbine mounted on the gearbox with built-in bypass
- Hydraulic system by rapid couplings to tractor
- Galvanized 5 wheel raingun trolley mounted on variable track hard rubber wheels



! NOTE !

- Specify gun when ordering

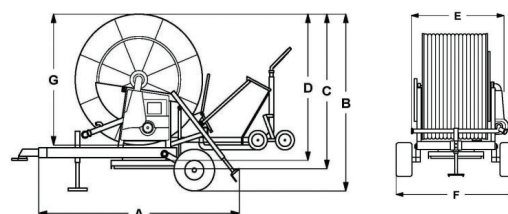

SIZE (cm)						
A	B	C	D	E	F	G
338	338	310	290	220	255	268

Dry Weight 2895 kg

* Please note dimensions and weights are to be used as a guide only.

MARANI HARD HOSE IRRIGATORS



IT060B



TECHNICAL DATA

Model	Pressure at Inlet (BAR)	Flow Rate (L/M)	Wetted Width at 80% (Mtr)
110/400	4.5 – 11.3	623 – 1501	62 – 92
110/450	4.4 – 11.9	522 – 1501	59 – 91
125/300	4.1 – 11.3	848 – 2144	70 – 112
125/350	4.3 – 11.2	848 – 1913	70 – 109

Description		Code
IT060B 110mm x 400m	G	IT060B110400
IT060B 110mm x 450m	J	IT060B110450
SIME Reflex		140052KIT
Nelson SR150 Gun		SR150K
Komet 160 Ultra		5010255KIT
IT060B 125mm x 300m	F	IT060B125300
IT060B 125mm x 350m	H	IT060B125350
SIME Explorer Big Gun 25°		140055KIT
Nelson SR200 Gun		SR200K
Komet 202 Ultra Kit		5010256KIT

Option	Code
Ma-Rain 26 Kit c/w solar panel and pressure switch	35462700KIT
Ma-Rain 56 Kit	35510120SKIT
Emptying Compressor	75430550

SIZES AVAILABLE

- 110mm x 400m
- 110mm x 450m
- 125mm x 300m
- 125mm x 350m

STANDARD EQUIPMENT

- Hydraulic lifting device of trolley
- 4 Speed gearbox
- Water Inlet Shut-Off Valve
- Hydraulic rotation of turntable
- PTO
- Pressure gauge (glycerine bath)
- Hydraulic feet
- Flexible connection pipe
- Tachometer
- Hydraulic lift of drawbar
- Hot galvanized chassis and reel
- Speed equalizer
- Winding handle
- Safety guards
- 5 Wheel trolley
- Hydraulic system by rapid couplings to tractor with storage reel
- Galvanized 5 wheel raingun trolley mounted on variable track hard rubber wheels
- Turbine mounted on the gearbox with built-in bypass

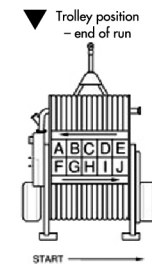

! NOTE !

- Specify gun when ordering

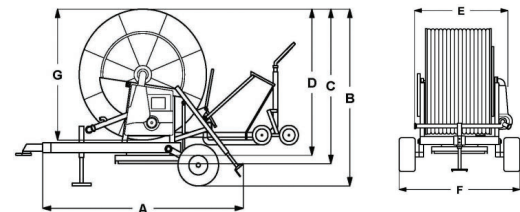

SIZE (cm)						
A	B	C	D	E	F	G
400	336	330	303	252	283	280

Dry Weight 3350 kg

* Please note dimensions and weights are to be used as a guide only.

IT070B



TECHNICAL DATA

Model	Pressure at Inlet (BAR)	Flow Rate (L/M)	Wetted Width at 80% (Mtr)
125/400	4.4 – 10.9	848 – 1988	70 – 106

Description	Code
IT070B 125mm x 400m	H
SIME Explorer Big Gun 25°	140055KIT
SIME Gemini 25° 2 Speed	140085KIT
Nelson SR200 Gun	SR200K
Komet 202 Ultra Kit	5010256KIT

Option	Code
Ma-Rain 26 Kit c/w solar panel and pressure switch	35462700KIT
Ma-Rain 56 Kit	35510120SKIT
Emptying Compressor	75430550
4 Wheel chassis upgrade	15275672
Wheels upgrade 13.0/55-16 14 PR 6	15275890

SIZES AVAILABLE

- 125mm x 400m

STANDARD EQUIPMENT

- Hydraulic lifting device of trolley
- PTO
- Winding handle
- Hydraulic rotation of turntable
- Hot galvanized chassis and reel
- Pressure gauge (glycerine bath)
- Hydraulic feet
- Safety guards
- Water Inlet Shut-Off Valve
- Hydraulic lift of drawbar
- Tachometer
- Speed equalizer
- Hydraulic system by rapid couplings to tractor
- Turbine mounted on the gearbox with built-in bypass
- Flexible connection pipe with storage reel
- 4 Speed gearbox
- Galvanized 5 wheel raingun trolley mounted on variable hard rubber wheels
- 2 Large floatation wheels



! NOTE !

- Specify gun when ordering

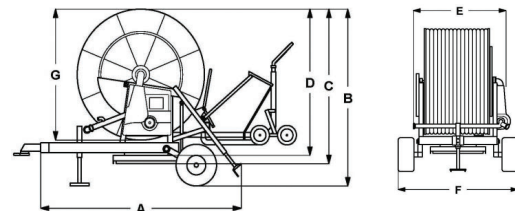

SIZE (cm)						
A	B	C	D	E	F	G
400	383	355	330	240	274	309

Dry Weight 3850 kg

* Please note dimensions and weights are to be used as a guide only.



MARANI HARD HOSE IRRIGATORS



ITS080B



TECHNICAL DATA

Model	Pressure at Inlet (BAR)	Flow Rate (L/M)	Wetted Width at 80% (Mtr)
110/600	4.8 – 11.5	522 – 1149	59 – 86
125/450	4.6 – 11.0	848 – 1901	70 – 102
125/500	4.7 – 11.4	848 – 1774	70 – 102

Description		Code
ITS080B 110mm x 600m	A	ITS080B110600
ITS080B 125mm x 450m	D	ITS080B125450
SIME Reflex		140052KIT
Nelson SR150 Gun		SR150K
Komet 160 Ultra		5010255KIT
ITS080B 125mm x 500m	B	ITS080B125500
SIME Explorer Big Gun 25°		140055KIT
SIME Mariner Big Gun		140075KIT
SIME Gemini 25° 2 Speed		140085KIT
Nelson SR200 Gun		SR200K
Komet 202 Ultra Kit		5010256KIT

Option	Code
Ma-Rain 26 Kit c/w solar panel and pressure switch	35462704KIT
Ma-Rain 56 Kit	35510120SKIT
Emptying Compressor	81670000

SIZES AVAILABLE

- 110mm x 600m
- 125mm x 450m
- 125mm x 500m

STANDARD EQUIPMENT

- Hydraulic lifting device of trolley
- PTO
- Winding handle
- Hydraulic rotation of turntable
- Hot galvanized chassis and reel
- Pressure gauge (glycerine bath)
- Hydraulic feet
- Safety guards
- Water Inlet Shut-Off Valve
- Hydraulic lift of drawbar
- Tachometer
- Speed equalizer
- Hydraulic system by rapid couplings to tractor
- Turbine mounted on the gearbox with built-in bypass
- Flexible connection pipe with storage reel
- 4 Speed gearbox
- Galvanized 5 wheel raingun trolley mounted on variable hard rubber wheels
- Four wheel chassis kit as standard



! NOTE !

- Specify gun when ordering

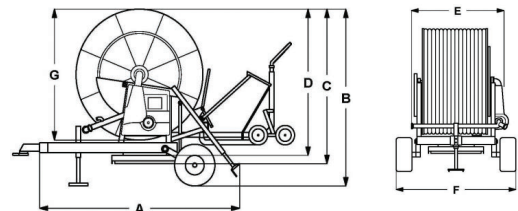

SIZE (cm)						
A	B	C	D	E	F	G
410	395	365	348	249	282	309

Dry Weight 5349 kg

* Please note dimensions and weights are to be used as a guide only.



MARANI HARD HOSE IRRIGATORS

MARANI HARD HOSE IRRIGATORS

ITS080C



TECHNICAL DATA

Model	Pressure at Inlet (BAR)	Flow Rate (L/M)	Wetted Width at 80% (Mtr)
140/400	4.2 - 12.0	974 - 2648	77 - 117
140/450	4.3 - 10.9	974 - 2455	77 - 110

Description	Code
ITS080C 140mm x 400m	ITS080C140400
ITS080C 140mm x 450m	ITS080C140450
SIME Explorer Big Gun 25°	140055KIT
SIME Gemini 25° 2 Speed	140085KIT
Nelson SR200 Gun	SR200K
Komet 202 Ultra Kit	5010256KIT

Option	Code
Ma-Rain 26 Kit c/w solar panel and pressure switch	35462700KIT
Ma-Rain 56 Kit	35510120SKIT
Emptying Compressor	81670000

SIZES AVAILABLE

- 140mm x 400m
- 140mm x 450m

STANDARD EQUIPMENT

- Hydraulic lifting device of trolley
- PTO
- Winding handle
- Hydraulic rotation of turntable
- Hot galvanized chassis and reel
- Pressure gauge (glycerine bath)
- Hydraulic feet
- Safety guards
- Water Inlet Shut-Off Valve
- Hydraulic lift of drawbar
- Tachometer
- Speed equalizer
- Hydraulic system by rapid couplings to tractor
- Turbine mounted on the gearbox with built-in bypass
- Flexible connection pipe with storage reel
- 4 Speed gearbox
- Galvanized 5 wheel raingun trolley mounted on variable hard rubber wheels
- Four wheel chassis kit as standard



! NOTE !

- Specify gun when ordering

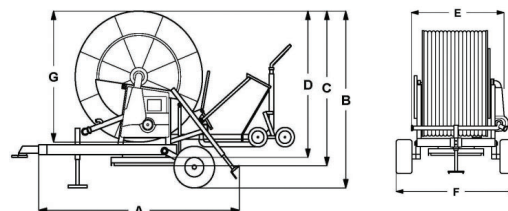

SIZE (cm)						
A	B	C	D	E	F	G
410	395	365	348	249	282	309

Dry Weight 5349 kg

* Please note dimensions and weights are to be used as a guide only.

MARANI HARD HOSE IRRIGATORS



ITS090C



TECHNICAL DATA

Model	Pressure at Inlet (BAR)	Flow Rate (L/M)	Wetted Width at 80% (Mtr)
140/500	4.4 – 11.5	974 - 2455	77 - 110

Description		Code
ITS090C 140mm x 500m	B	ITS090C140500
SIME Explorer Big Gun 25°		140055
SIME Gemini 25° 2 Speed		140085
Nelson SR200 Gun		SR200K
Komet 202 Ultra Kit		5010256KIT

SIZES AVAILABLE

- 140mm x 500m

STANDARD EQUIPMENT

- Hydraulic lifting device of trolley
- PTO
- Winding handle
- Hydraulic rotation of turntable
- Hot galvanized chassis and reel
- Pressure gauge (glycerine bath)
- Hydraulic feet
- Safety guards
- Electric Water Inlet Shut-Off Valve
- Hydraulic lift of drawbar
- 4 Speed gearbox
- Ma-Rain 56 Computer
- Hydraulic system by rapid couplings to tractor
- Turbine mounted on the gearbox with double built-in bypass
- Flexible connection pipe with storage reel
- Galvanized 5 wheel raingun trolley mounted on variable hard rubber wheels
- Four wheel chassis kit as standard
- Emptying compressor



! NOTE !

- Specify gun when ordering

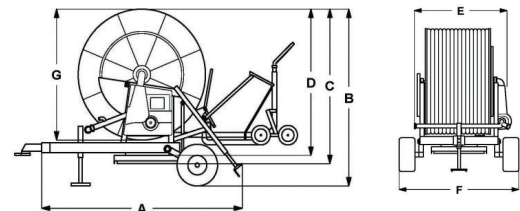

SIZE (cm)						
A	B	C	D	E	F	G
450	430	390	376	218	297	334

Dry Weight 5897 kg

* Please note dimensions and weights are to be used as a guide only.

IT100B



TECHNICAL DATA

Model	Pressure at Inlet (BAR)	Flow Rate (L/M)	Wetted Width at 80% (Mtr)
140/550	4.6 – 12.6	974 – 2455	77 – 110
140/600	4.7 – 13.1	974 – 2455	77 – 110
140/700	4.4 – 11.0	974 – 2455	77 – 110

Description	Code
IT100B 140mm x 550m	ITS100B140550
IT100B 140mm x 600m	ITS100B140600
IT100B 140mm x 700m	ITS100B140700
SIME Explorer Big Gun 25°	140055
SIME Gemini 25° 2 Speed	140085
Nelson SR200 Gun	SR200K
Komet 202 Ultra Kit	5010256KIT

SIZES AVAILABLE

- 140mm x 550m
- 140mm x 600m
- 140mm x 700m

STANDARD EQUIPMENT

- Hydraulic lifting device of trolley
- PTO
- Winding handle
- Hydraulic rotation of turntable
- Hot galvanized chassis and reel
- Pressure gauge (glycerine bath)
- Hydraulic feet
- Safety guards
- Electric Water Inlet Shut-Off Valve
- Hydraulic lift of drawbar
- 4 Speed gearbox
- Ma-Rain 56 Computer
- Hydraulic system by rapid couplings to tractor
- Turbine mounted on the gearbox with double built-in bypass
- Flexible connection pipe with storage reel
- Galvanized 5 wheel raingun trolley mounted on variable hard rubber wheels
- Four wheel chassis kit as standard
- Emptying compressor



! NOTE !

- Specify gun when ordering

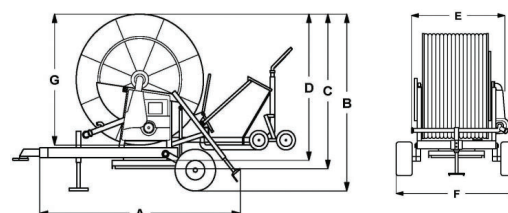

SIZE (cm)						
A	B	C	D	E	F	G
498	450	420	396	265	312	363

Dry Weight 7250 kg

* Please note dimensions and weights are to be used as a guide only.



One of the largest specific ranges of poly reel irrigators available worldwide - Ranging from a 40mm to a 160mm machine.



Proud to be your partner in irrigation